

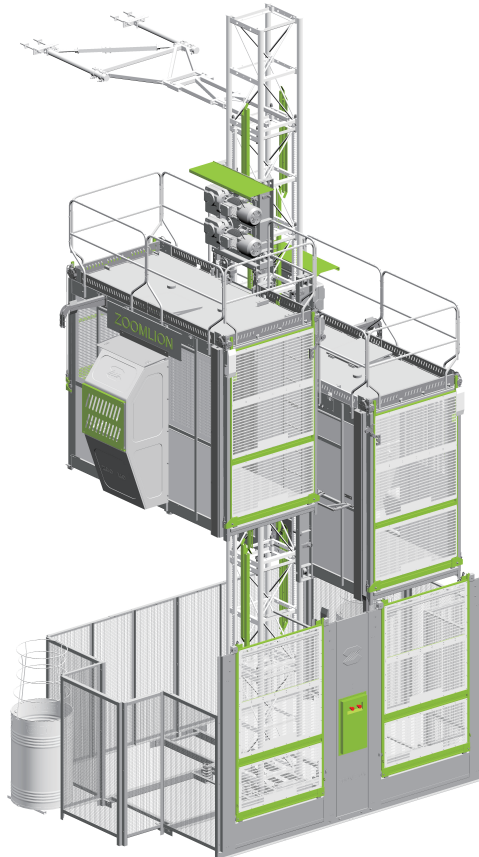



















ZOOMLION

# 施工升降机 Construction Hoist Elevadores de construção Elevadores de construcción













## 技术参数 / Technical Parameter / Parâmetros técnicos / Parâmetro técnico











### 普通梯 / General hoist / Elevador comum / Elevador general

		 (kg)	 (m/mim)	 kW(50/87 Hz)	 (m)	 (m)		H (m)						
SC200/200EB-A1		2×2000	50	2×2×11/18.5	0.65×0.65×1.508	3.2×1.5×2.5 3.2×1.5×2.2		≤200						
SC200EB-A1				2×11/18.5										
SC200/200EB-B1		2×2000	58	2×2×13/22			0.65×0.65×1.508	3.2×1.5×2.5 3.2×1.5×2.2		≤300				
SC200EB-B1				2×13/22										
SC200/200BZ-A		2×2000	63	2×3×11/18.5					0.65×0.65×1.508	3.2×1.5×2.5 3.2×1.5×2.2		≤300		
SC200BZ-A				3×11/18.5										
SC200/200BG-A		2×2000	80	2×3×15/26							0.65×0.65×1.508	3.2×1.5×2.5 3.2×1.5×2.2		≤500
SC200BG-A				2×15/26										











### 无人机 / Unmanned operating hoist / Escadas não tripuladas / Elevador sin operador

		 (kg)	 (m/mim)	 kW(50/87 Hz)	 (m)	 (m)		H (m)
SC200/200EB-A2		2×2000	50	2×2×11/18.5	0.65×0.65×1.508	3.2×1.5×2.5		≤200
SC200EB-A2				2×11/18.5				



### 货梯 / Material hoist / Elevador de material / Elevador de material

		 (kg)	 (m/mim)	 kW(50/87 Hz)	 (m)	 (m)		H (m)
SC120/120H		2×1200	30	2×9/15	0.65×0.65×1.508	3.0×1.5×2.1		≤100
SC120H				9/15				

### 倾斜梯 / Inclined hoist / Elevador inclinado / Elevador inclinado

		 (kg)	 (m/mim)	 kW(50/87 Hz)	 (m)	 (m)		H (m)
SCQ200/200EB-A1		2×2000	50	2×2×11/18.5	0.65×0.65×1.508	3.2×1.5×2.4		≤200
SCQ200EB-A1				2×11/18.5				

### 井道梯 / Modular shaft hoist / Elevador para poço/ Elevador de eje modular

		 (kg)	 (m/mim)	 kW(50/87 Hz)	 (m)	 (m)		H (m)
SC200EB-J		2000	50	2×11/18.5	0.65×0.2×1.508	1.8-2.1×1.5×2.5 1.8-2.1×1.5×3.1		≤260



导轨架 / Mast / Mastro da cremalheira / Tramo de guía

J4.5 J6 J8 J10		D4.5	
适用于 / apply to / Aplicável a / Aplicar para □ □ ▽ ◻		适用于 / apply to / Aplicável a / Aplicar para □ □ ▽ ◻	
B4.5 B6 B8 B10 Z6/4.5 Z8/6 Z10/8		B4.5 B6 B8 B10 Z6/4.5 Z8/6 Z10/8	
适用于 / apply to / Aplicável a / Aplicar para □ ◻		适用于 / apply to / Aplicável a / Aplicar para □ □ ▽ ◻	
J4.5 J6	B4.5 B6 Z6/4.5	D4.5	
适用于 / apply to / Aplicável a / Aplicar para □			



导轨架 / Mast / Mastro da cremalheira / Tramo de guía

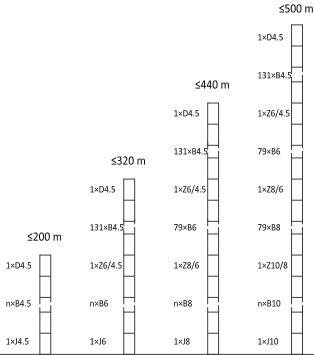

适用于/apply to/Aplicável a /Aplicar para

- SC200EB-A1
- SC200/200EB-A1
- SC200EB-B1
- SC200/200EB-B1
- SC200EB-A2
- SC200/200EB-A2
- SCQ200EB-A1
- SCQ200/200EB-A1
- SC120H
- SC120/120H

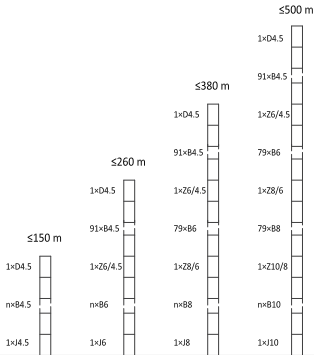

适用于/apply to/Aplicável a /Aplicar para

- SC200BZ-A
- SC200/200BZ-A
- SC200BG-A
- SC200/200BG-A

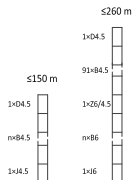

适用于/apply to/Aplicável a /Aplicar para

- SC200EB-J

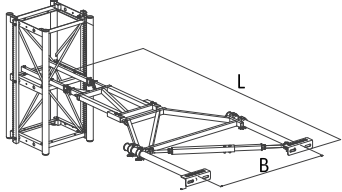
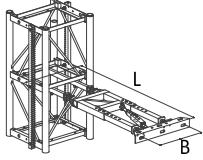
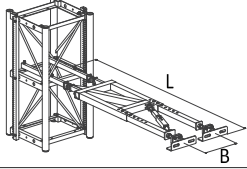
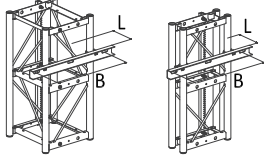

附着装置 / Mast Tie / Dispositivo de fixação/Arriostramiento

型号Type Typ	L/(m)	B/(m)	
II A	2.8-3.2	1.5	
II B	3.0-3.6	1.75	
II C	3.4-4.2	2.0	
II D	3.0-3.6	1.5	
II E	2.4-2.8	1.3	
II G	4.2-5.0	2.2	
II D/VA-A	3.0-3.6/1.9-2.2	1.5/0.41	
II D/VA-C	2.85-3.45/1.75-2.05	1.5/0.41	
VA	1.7-2.0	0.61	
VB	2.0-2.3	0.61	
VD	1.75-2.05	0.53	
VE	2.0-2.3	0.53	
VF	2.3-2.7	0.53	
VI	0.441(0.216)	1	



附着装置 / Mast Tie / Dispositivo de fixação/Arriostramento

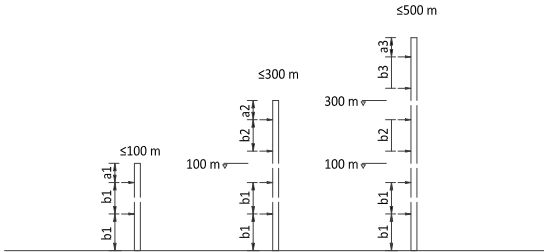

b1(m)	a1(m)	b2(m)	a2(m)	b3(m)	a3(m)
≤10.5	≤7.5	≤9	≤7.5	≤7.5	≤6

适用于/apply to/Aplicável a /Aplicar para

SC200EB-A1
SC200/200EB-A1
SC200EB-B1
SC200/200EB-B1
SC200BZ-A
SC200/200BZ-A
SC200BG-A
SC200/200BG-A
SC200EB-A2
SC200/200EB-A2
SC120H
SC120/120H

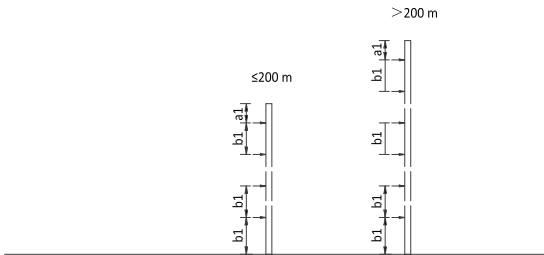

b1(m)	a1(m)
≤9	≤7.5

适用于/apply to/Aplicável a /Aplicar para

SCQ200EB-A1
SCQ200/200EB-A1



b1(m)	a1(m)
≤9	≤7.5

适用于/apply to/Aplicável a /Aplicar para

SC200EB-J
-----------

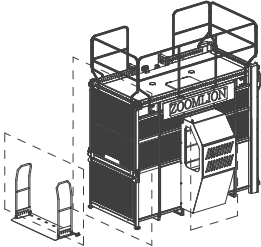
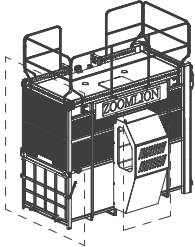
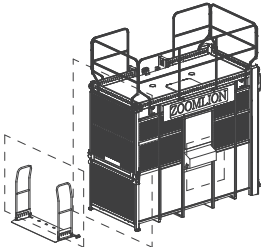
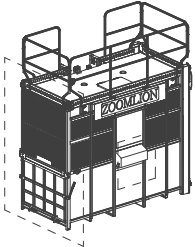
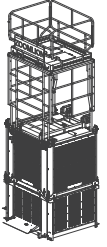
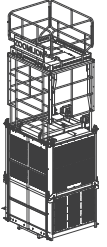
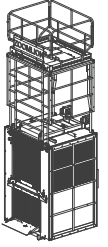

## 吊笼形式 / cage / Cabine / Jaula

		
<p><b>出料门双开门、带司机室、小翻板（选配）</b>          exit door in two parts \ driver's cab \ ramp door (optional)          Porta dupla para descarga, com cabine do operador, rampa pequena (opcional)          Puerta doble de descarga, cabina del conductor \ solapa pequeña (opcional)</p>	<p><b>出料门翻板门、带司机室</b>          exit door combined with manual operated load ramp \ driver's cab          Porta de descarga com rampa grande, com cabine do operador          Puerta de descarga con solapa grande, con cabina de conducción</p>	
		
<p><b>出料门双开门、操作箱、小翻板（选配）</b>          exit door in two parts \ operation box \ ramp door (optional)          Porta dupla para descarga, caixa de operação, rampa pequena (opcional)          Puerta doble de descarga, caixa de operación, puerta solapa pequeña (opcional)</p>	<p><b>出料门翻板门、操作箱</b>          exit door combined with manual operated load ramp \ operation box          Porta de descarga com rampa grande, caixa de operação          Puerta de descarga con solapa grande, caja de operación</p>	
		
<p>A B C</p>	<p>A B</p>	<p>C</p>

